

# IN10051BK RHIAN 6-LIGHT CHANDELIER

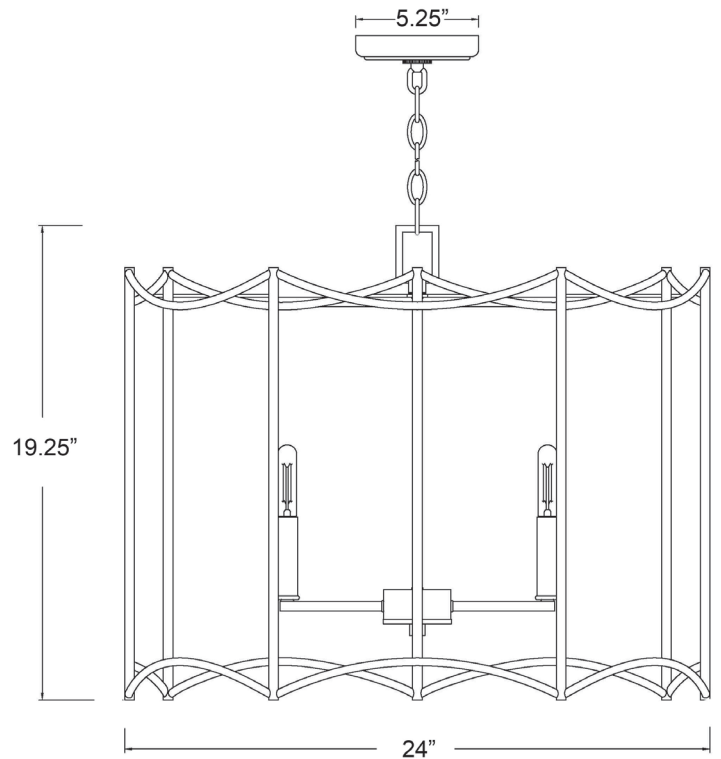

<b>Description:</b>	Rhian 6-light chandelier
<b>Finish:</b>	Matte Black
<b>Dimensions:</b>	24" W x 19-1/4" H
<b>Bulbs:</b>	6-60w Cand.
<b>Installed Weight:</b>	
<b>Certification:</b>	cETL / dry location

<b>Material:</b>	Steel
<b>Shades:</b>	NA
<b>Glass:</b>	NA
<b>Canopy Dimensions:</b>	5-1/4" Dia.
<b>Chain/Wire:</b>	5' chain, 12' wire
<b>Additional Finishes:</b>	NA